

Practice Test

ORExt

Grade 8

Science

**Scoring Protocol
and
Student Materials**

Oregon Department of Education
Behavioral Research and Teaching - UO

Oregon Extended Assessment Practice Test

Test Administration Instructions

This test form contains all materials you will need to administer the ORExt practice test, including the Scoring Protocol (SP) and Student Materials (SM).

- SP – includes administration directions, item prompts, and scoring information that the Qualified Assessor (QA) needs to administer the ORExt.
- SM – includes item prompts and answer choices for the student to review and select answers.
- In the SP all items are identified as Low (L), Medium (M), or High (H) difficulty at the beginning of the item prompt. Most Low level items have iconic answer choices to support student access. QAs may substitute objects or picture-symbols that the student is more familiar with for all Low level items.
- All instructions for the QA are written in parentheticals in the SP, e.g., (Point to student materials.). All prompts are written in plain text.
- The prompt is also written in the SM for the student to review. The SM contains three answer choices. Students can respond to prompts in their preferred communication modality (e.g., speech, sign, pointing, eye gaze, etc.).
- Follow all instructions provided in the SP. The majority of items can be read aloud entirely, including answer choices. When read aloud is not acceptable (only in ELA decoding items), the SP will explicitly state that the QA should NOT read the answer choices for that item.
- Provide the student the level of support that they need to access each test item (i.e., Full Physical, Partial Physical, Visual/Verbal/Gestural, or Full Independence), while not violating the item construct.
- Read directions carefully and deliberately to the student.
- Start with the directive statement to focus student attention on the SM.
- Read the item prompt (question) first (unless the student consistently needs the directive statement read to them).
- Move on to the next item if the student responds/selects an answer choice.
- Re-read the directive statement for the item if the student does not respond and then repeat the prompt. Re-read as often as necessary all directions, prompts, and directive statements.
- Point to each answer choice as it is read.
- Provide general praise of student effort, but do not lead the student to a correct answer.
- Move on to the next item after two attempts with no response and record a zero in the SP.
- Score all items as correct (=1) or incorrect (=0).

Item 1

Option:

A

B

C

Correct

Student
Response

L - Here are three objects. (Point to the objects.) Which is round: pizza, box, or kite?

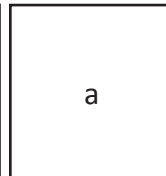
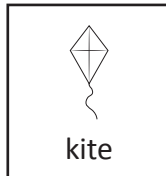
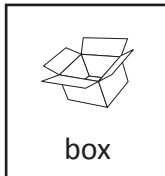
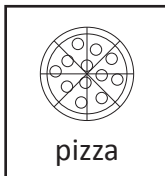

Scoring: 0 = incorrect; 1 = correct

Item 2

Option:

A

B

C

Correct

Student
Response

L - Here are three animals. (Point to answer choices.) Which animal is the biggest: elephant, bird, or rabbit?

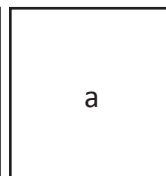
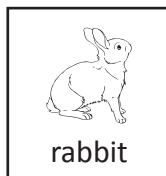
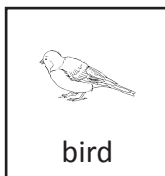
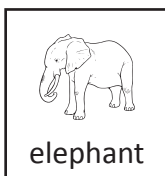

Scoring: 0 = incorrect; 1 = correct

Item 3

Option:

A

B

C

Correct

Student
Response

L - Here is Laura. (Point to picture of girl.) Which is Laura's hand: A, B, or C?

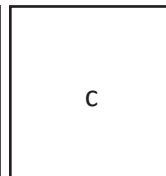
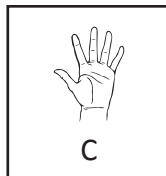
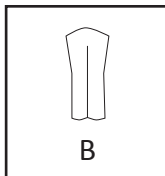
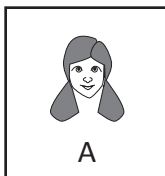

Scoring: 0 = incorrect; 1 = correct

Item 4

Option:

A

B

C

Correct

Student
Response

L - Here are three pictures. (Point to student materials.) Which shows rain: A, B, or C?

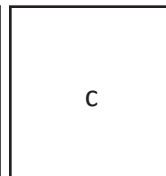
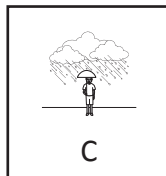
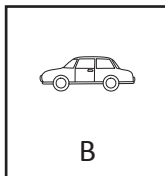
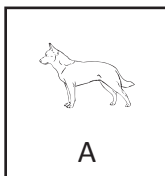

Scoring: 0 = incorrect; 1 = correct

Item 5

Option:

A

B

C

Correct

Student
Response

M - Here are three pictures. (Point to student materials.) Which is the Earth: A, B, or C?

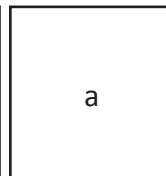
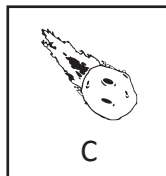
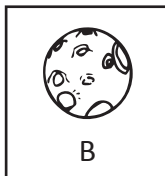

Scoring: 0 = incorrect; 1 = correct

Item 6

Option:

A

B

C

Correct

Student
Response

M - This is an eagle. (Point to eagle.) What trait does an eagle use to grab its prey: wings, trunk, or talons?

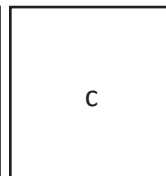
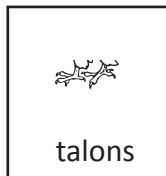

Scoring: 0 = incorrect; 1 = correct

Item 7

Option:

A

B

C

Correct

Student
Response

M - Here are three pictures. (Point to answer choices.) Which is a solid form of water: glass, river, or ice cubes?

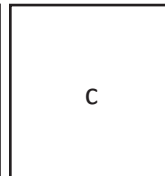
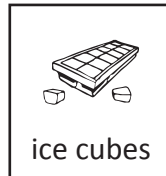
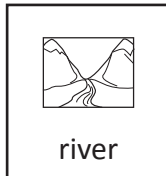

Scoring: 0 = incorrect; 1 = correct

Item 8

Option:

A

B

C

Correct

Student
Response

M - Dave is sometimes late for the bus. (Point to materials.) Which could help Dave be on time for his bus: calculator, candle, or bus schedule?

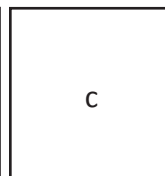
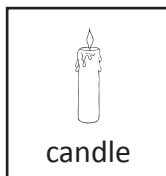
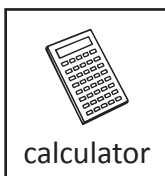

Scoring: 0 = incorrect; 1 = correct

Item 9

Option:

A

B

C

Correct

Student
Response

H - This is a cougar. (Point to cougar.) Which could compete with the cougar for food: grass, ant, or wolf?

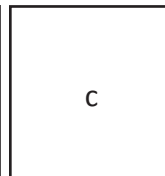
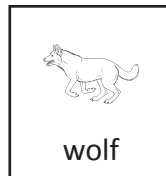
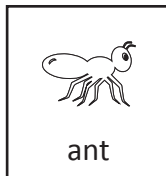
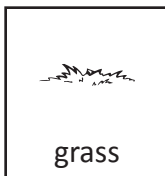

Scoring: 0 = incorrect; 1 = correct

Item 10

Option:

A

B

C

Correct

Student
Response

H - Here is an extinct dinosaur. (Point to the prompt.) Which is also an extinct dinosaur: A, B, or C?

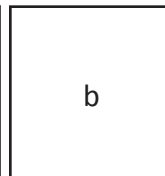
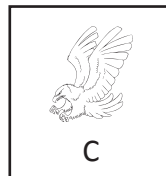
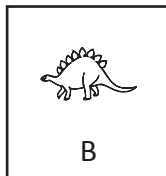
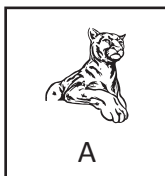

Scoring: 0 = incorrect; 1 = correct

Item 11

Option:

A

B

C

Correct

Student
Response

H - This is a pot of water. (Point to prompt.) Which would transfer heat to the water: stove, refrigerator, or washing machine?

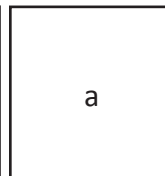
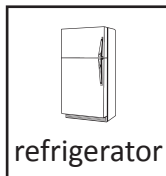

Scoring: 0 = incorrect; 1 = correct

Item 12

Option:

A

B

C

Correct

Student
Response

H - Here is a logger. (Point to the prompt.) Which natural resource is used for logging: trees, coal, or water?

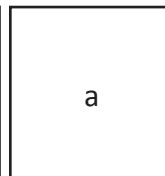
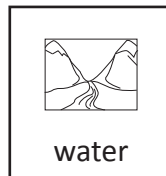
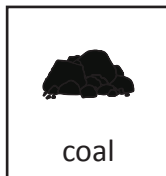

Scoring: 0 = incorrect; 1 = correct

Item 1

Which is round?

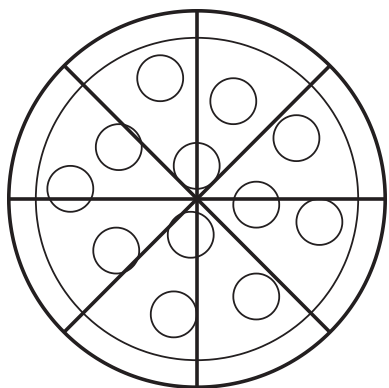

pizza

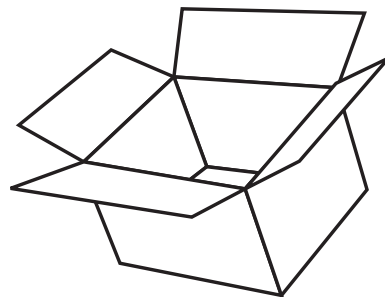

box

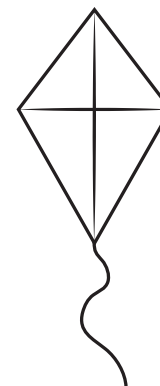

kite

Which animal is the biggest?

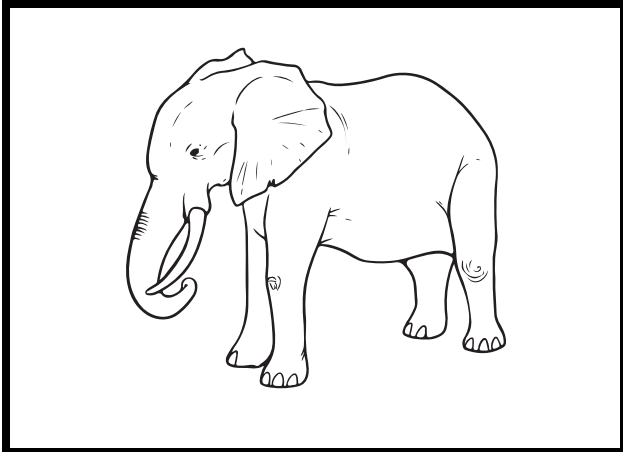

elephant

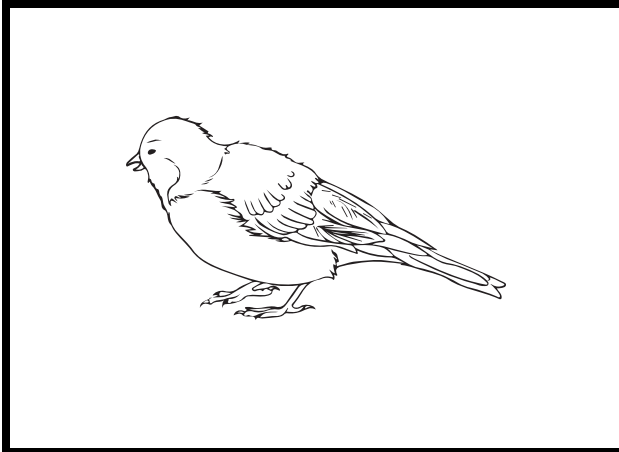

bird

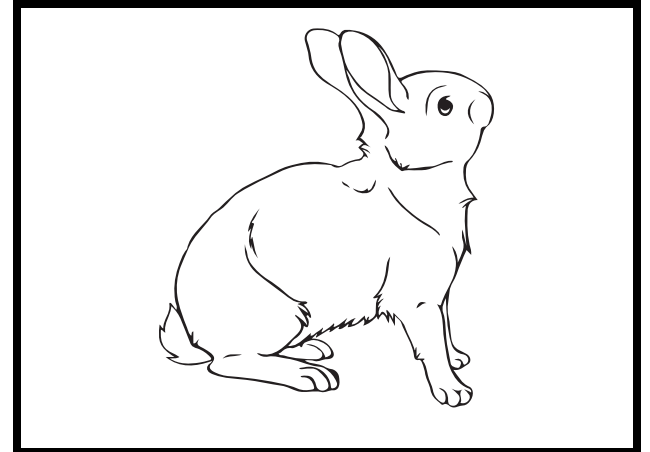

rabbit

Which is Laura's hand?

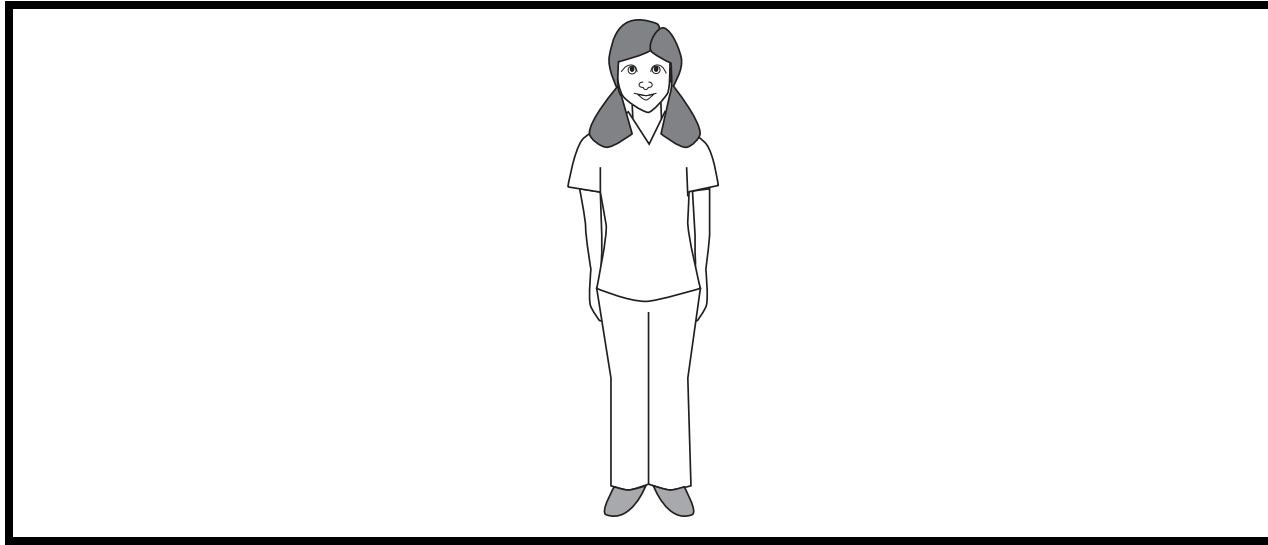

A

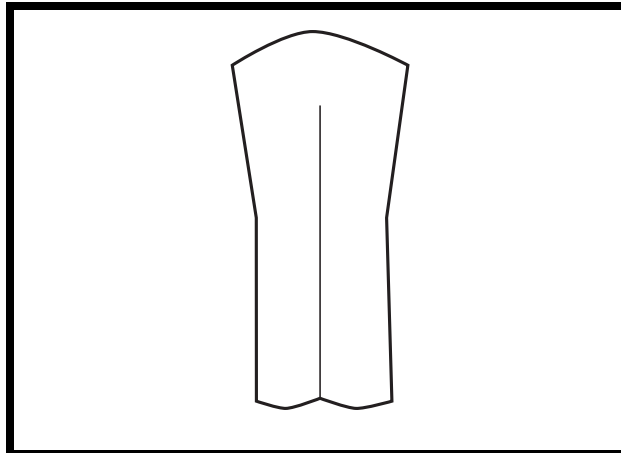

B

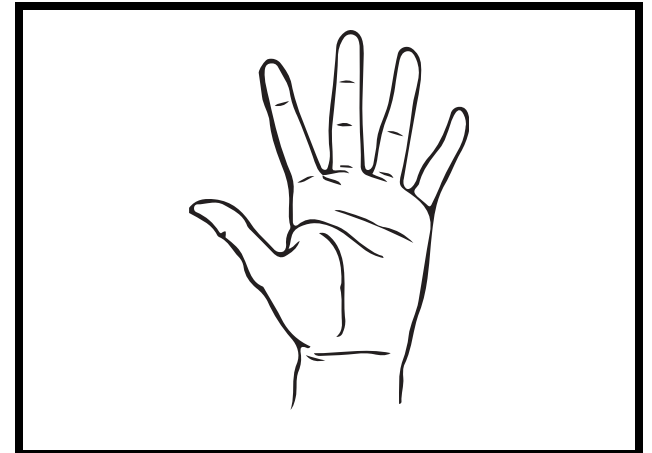

C

Which shows rain?

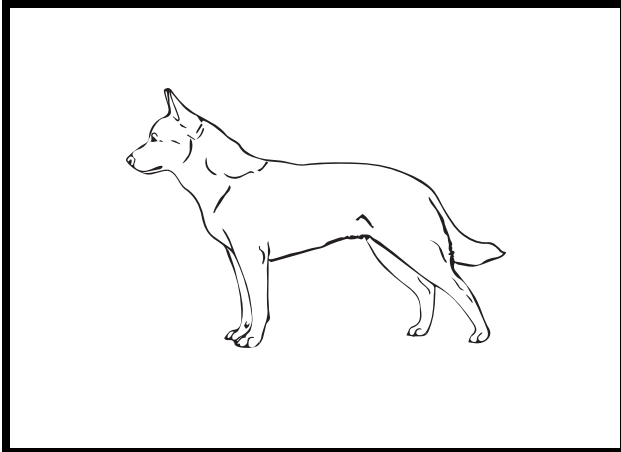

A

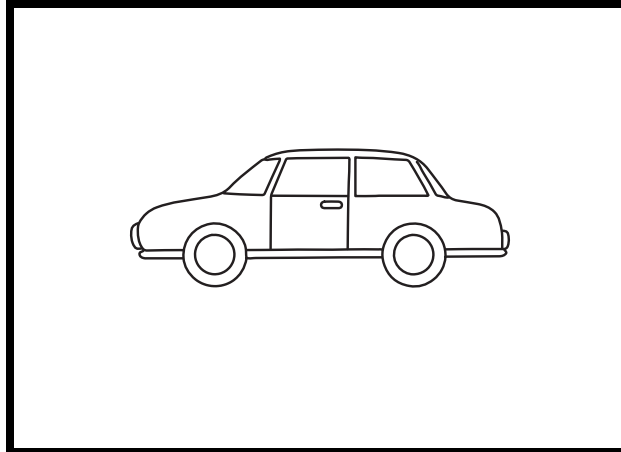

B



C

Which is the Earth?

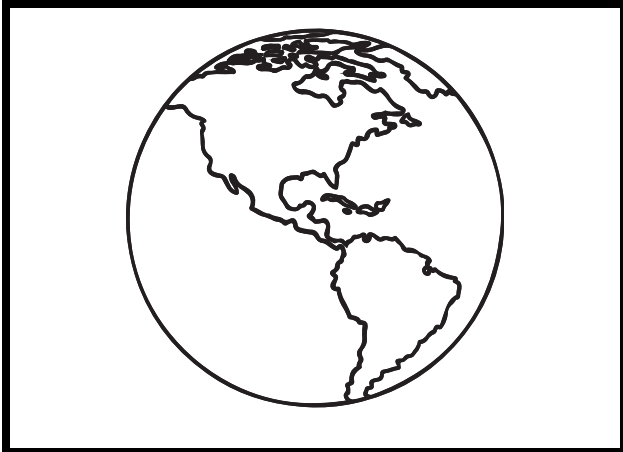

A

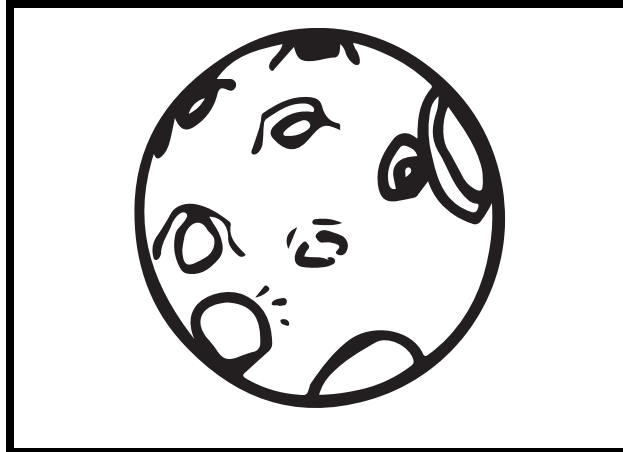

B

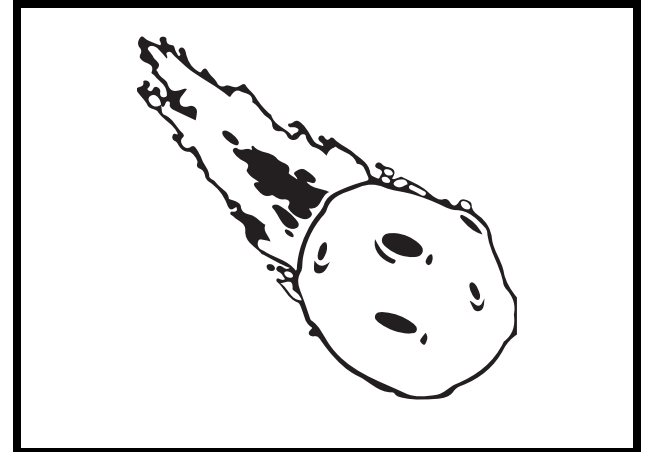

C

What trait does an eagle use to grab its prey?

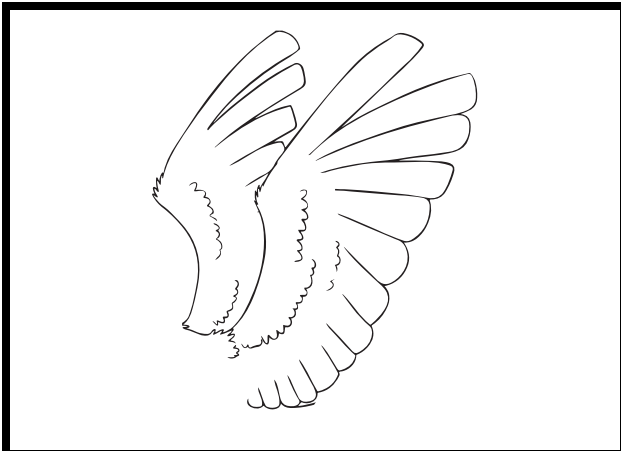
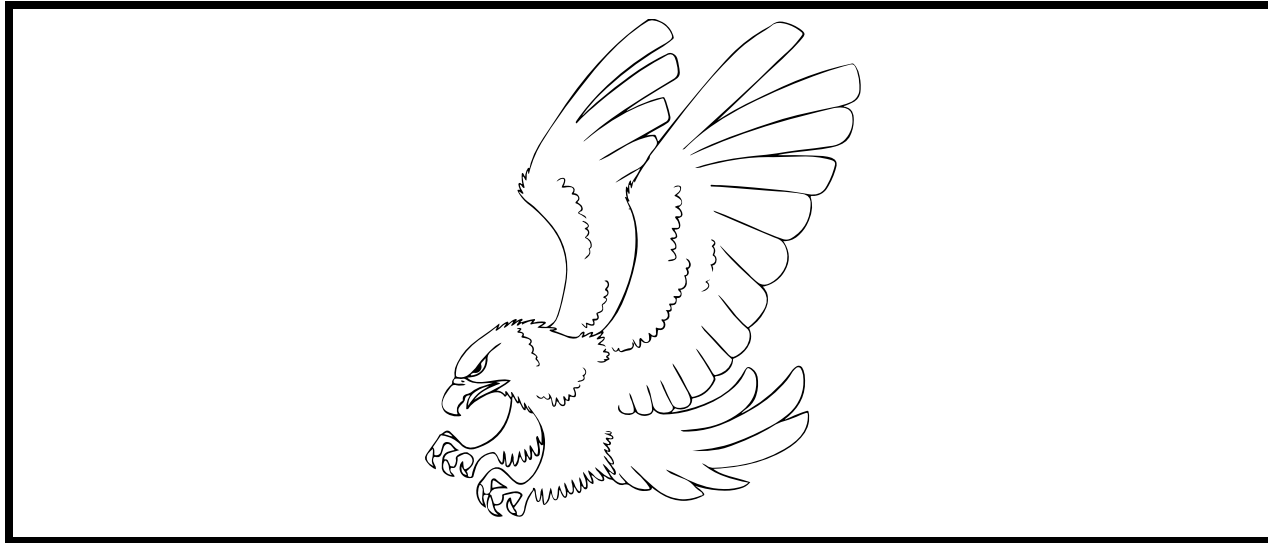

wings

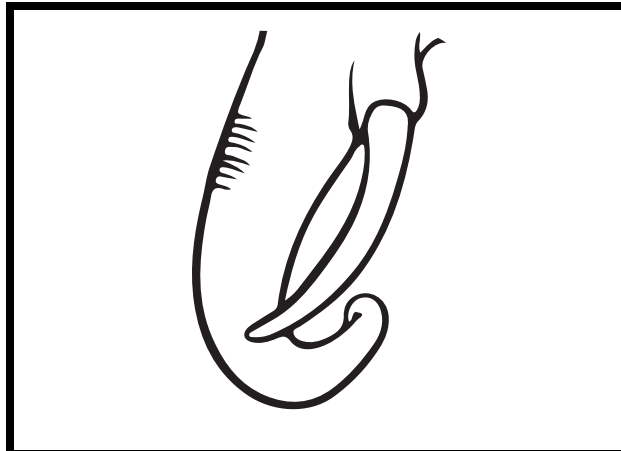

trunk

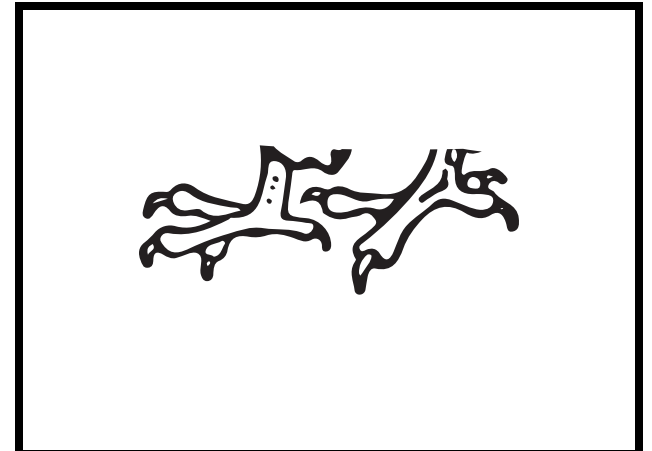

talon

Which is a solid form of water?

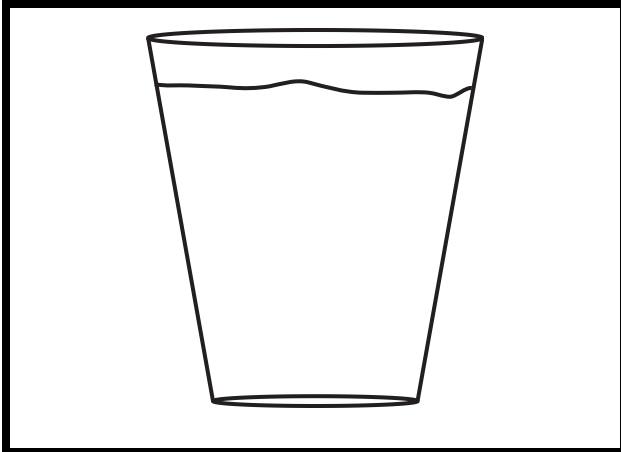

glass

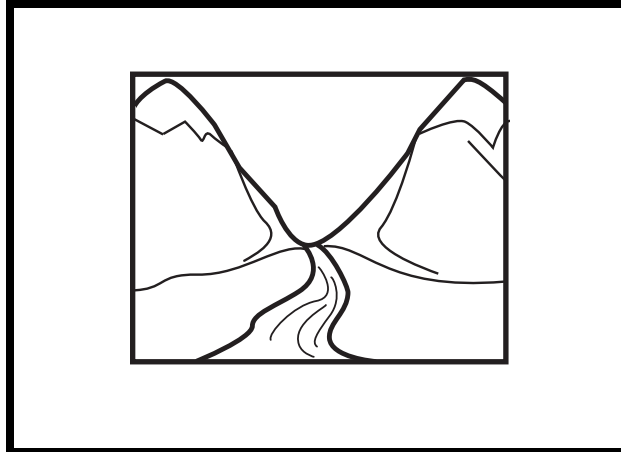

river

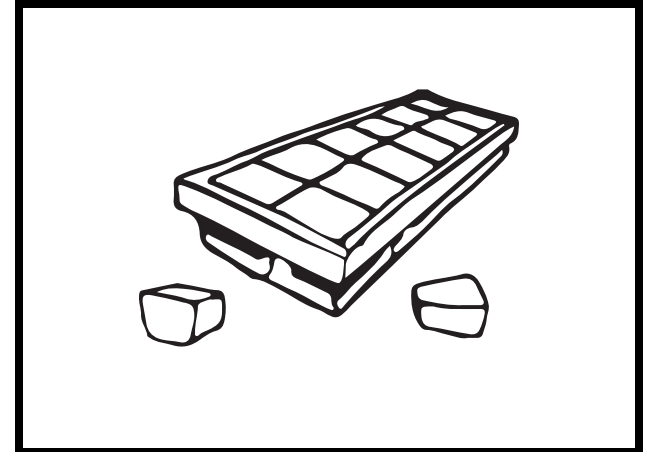

ice cubes

Item 8

Dave is sometimes late for the bus. Which could help Dave be on time for his bus?

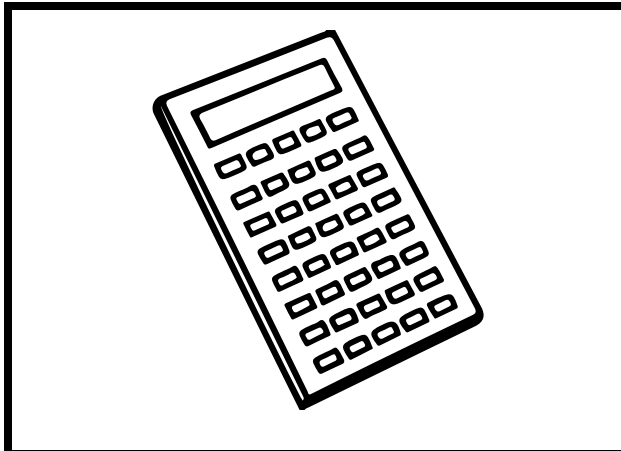
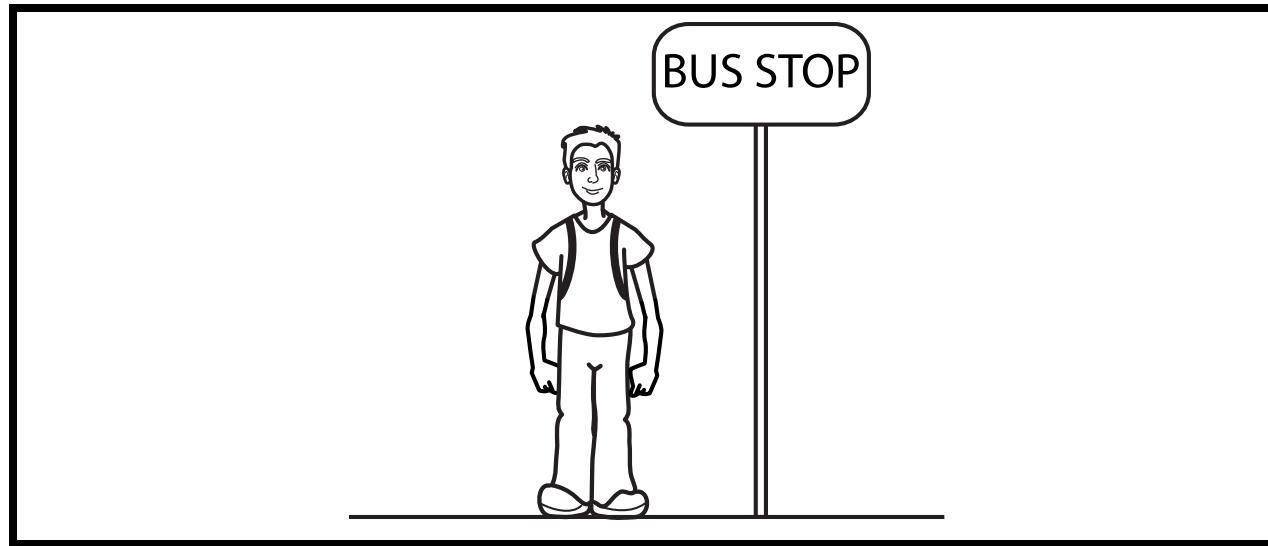

calculator

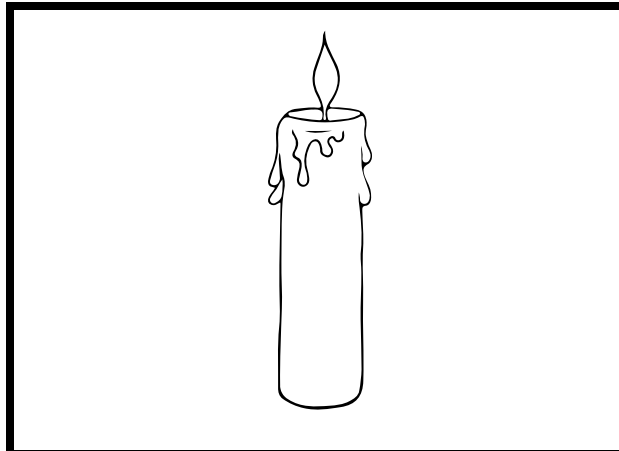

candle

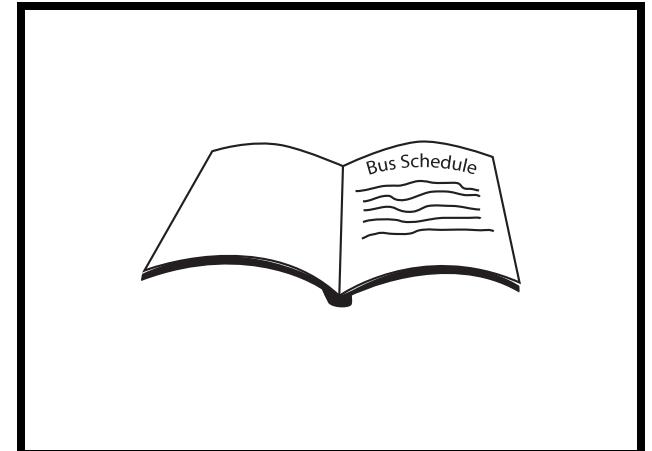

bus schedule

Which could compete with the cougar for food?

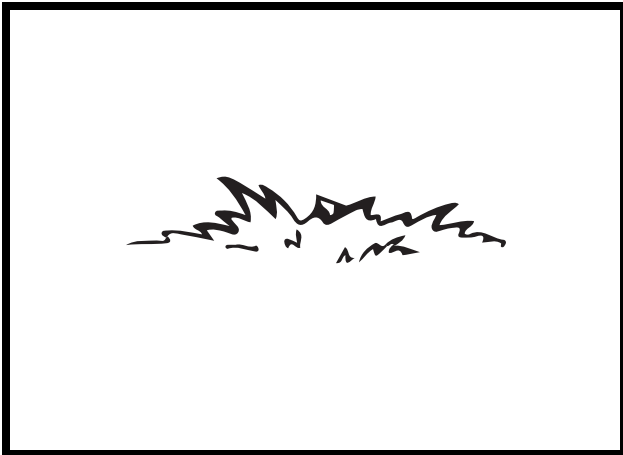
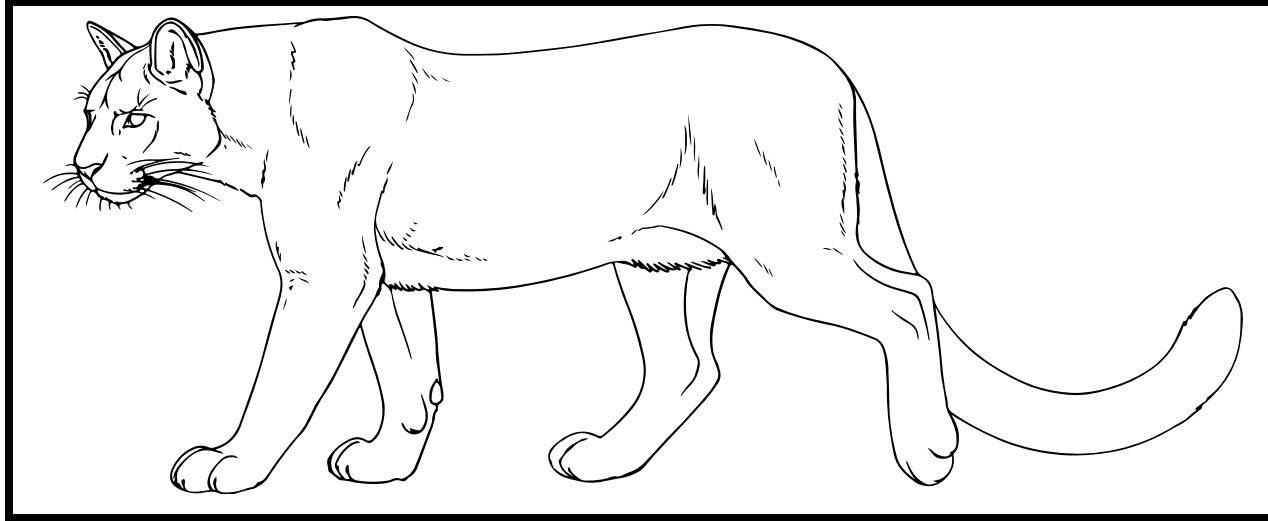

grass

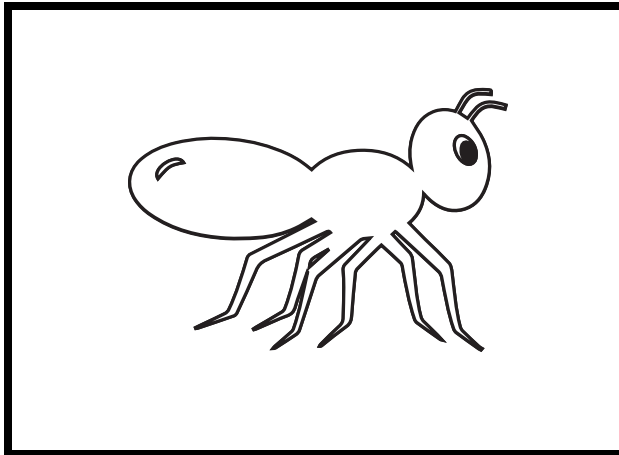

ant

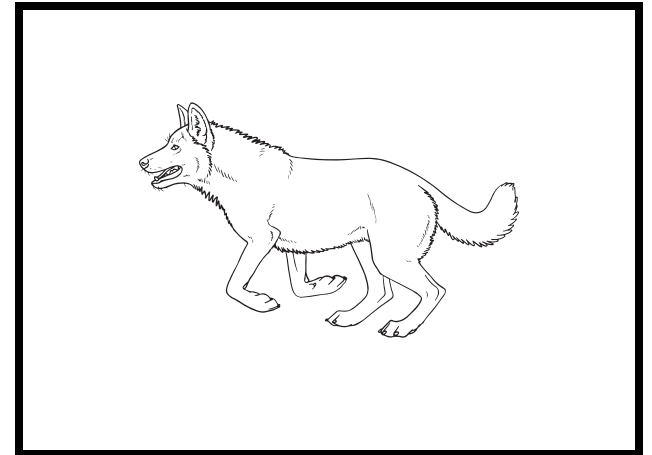

wolf

Which is also an extinct dinosaur?

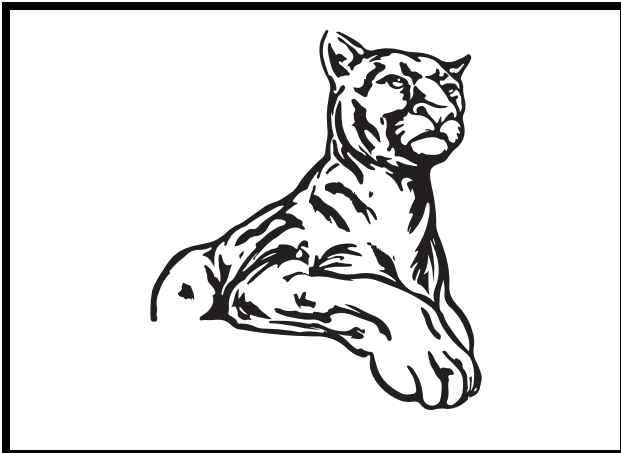
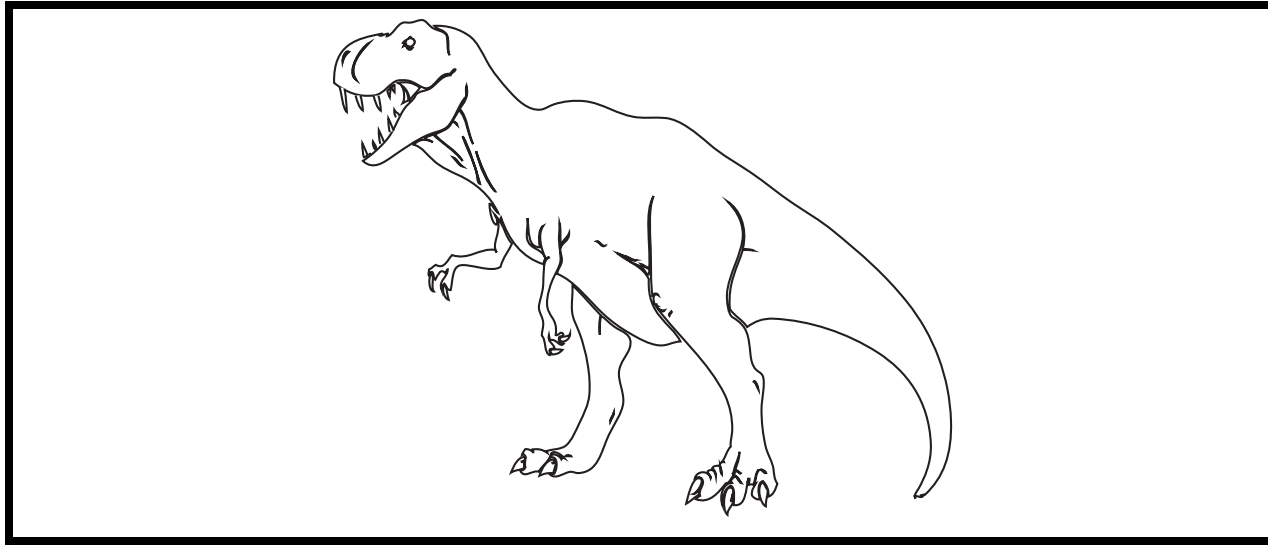

A

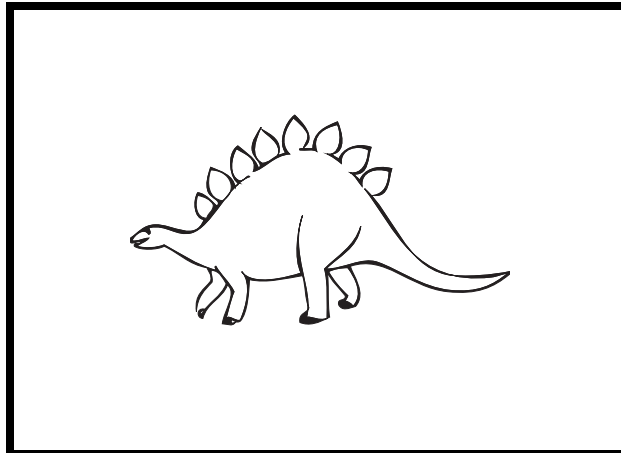

B

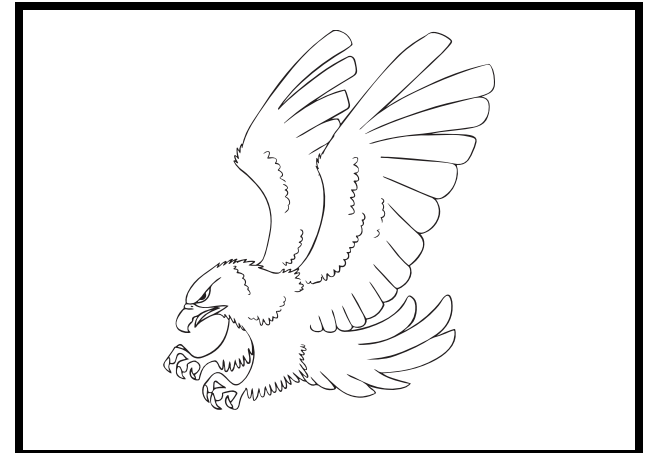

C

Which would transfer heat to the water?

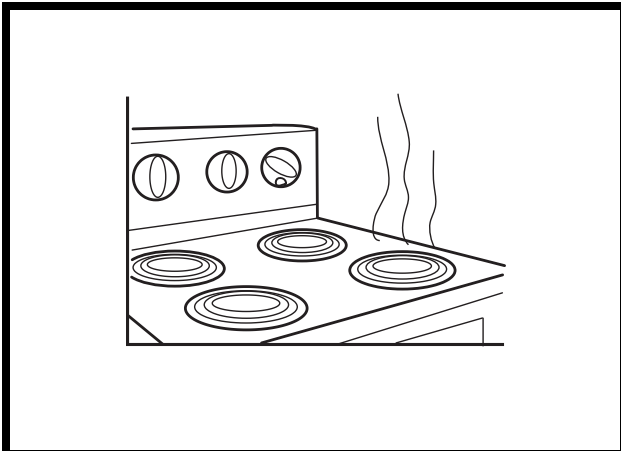
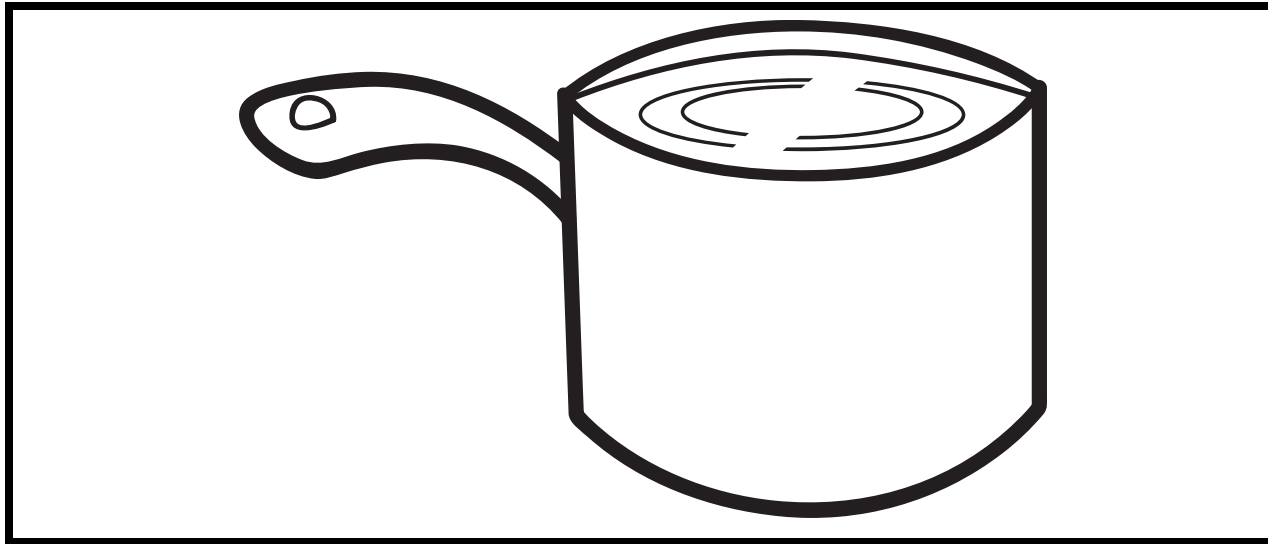

stove

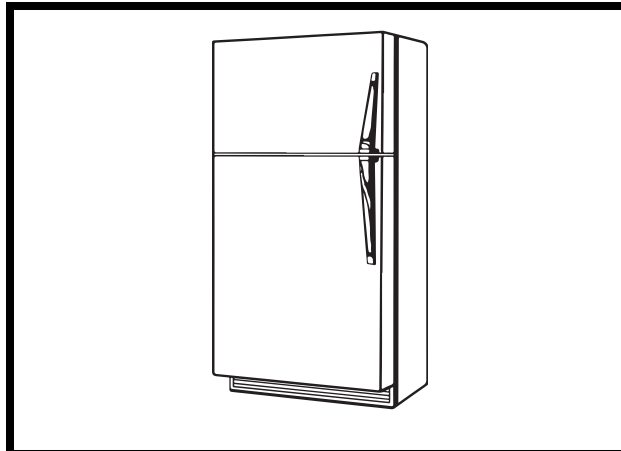

refrigerator

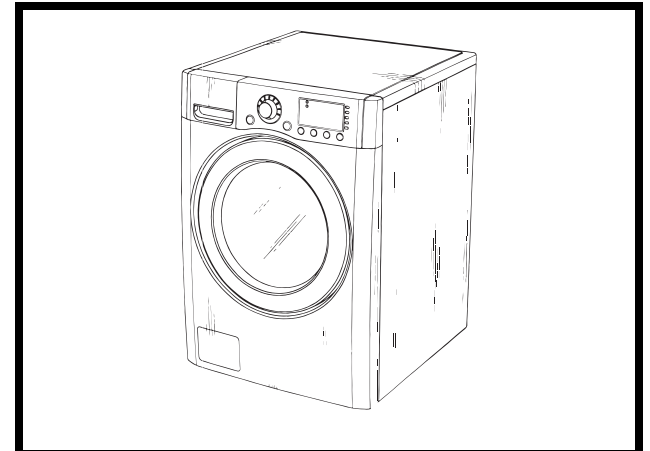

washing machine

Which natural resource is used for logging?

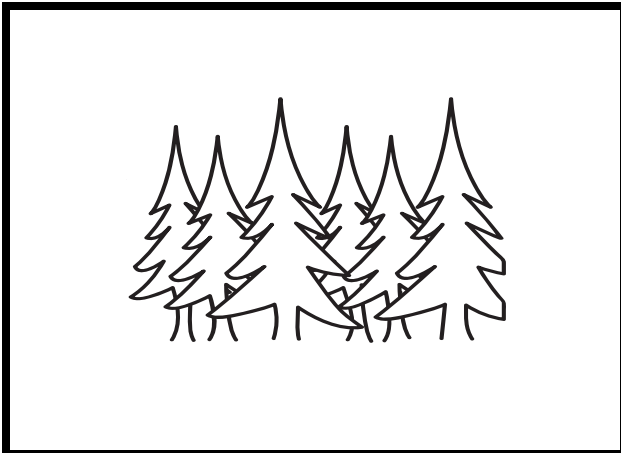
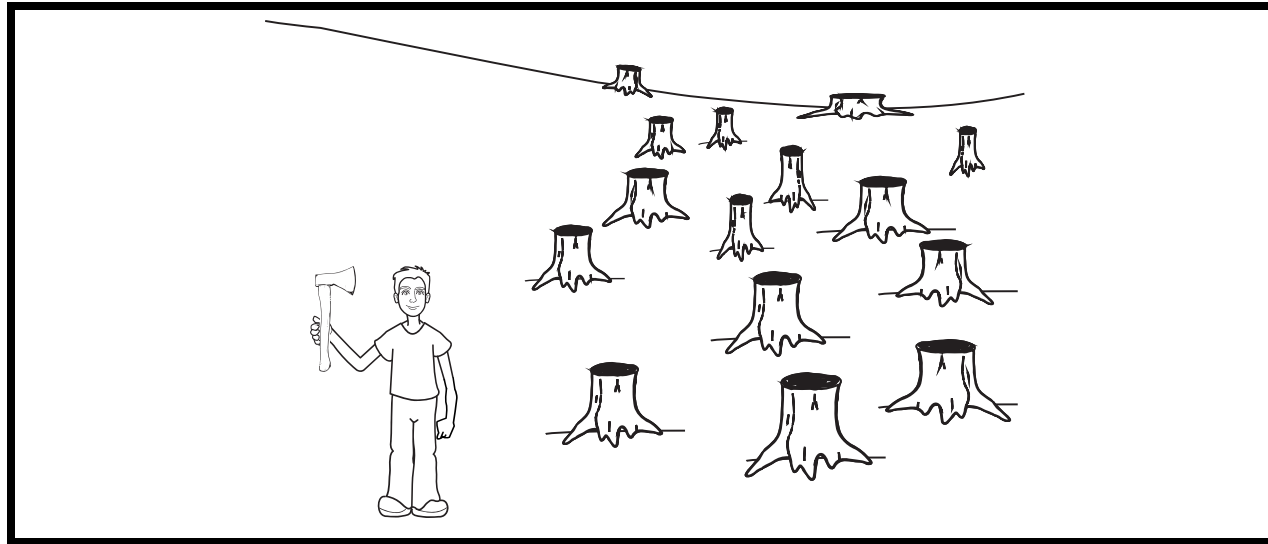

trees

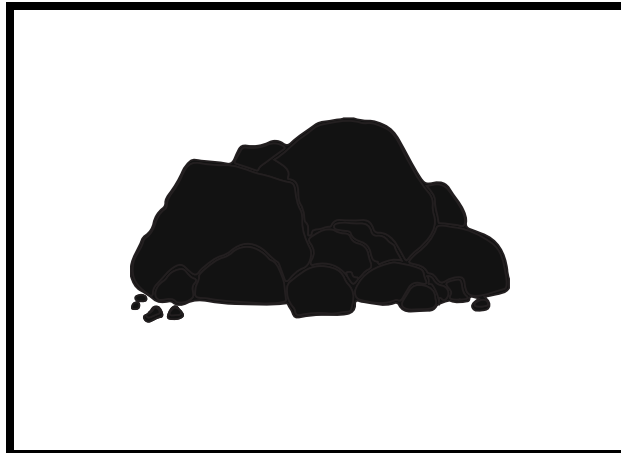

coal

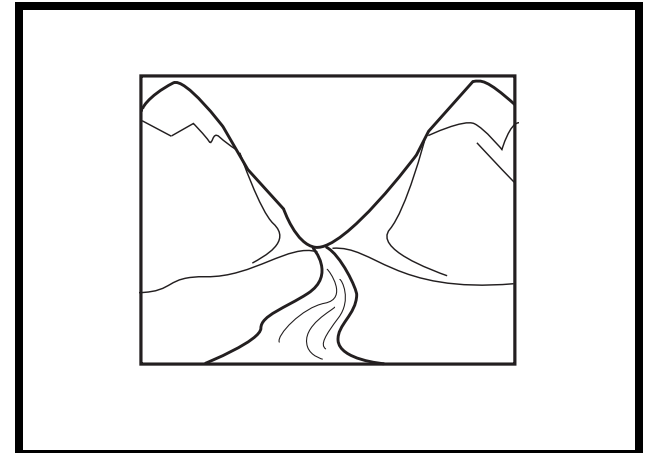

water